

Fluid control valve(2/2 way)

2KW Series (Direct-acting and normally opened)

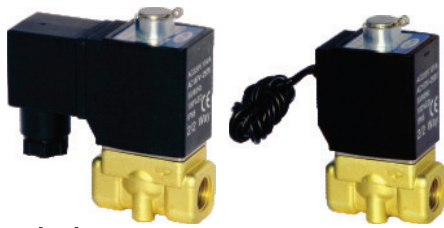

Symbol



Product feature

1. Direct acting and normally opened type 2/2 way solenoid valve. Its high sensibility allows it to change direction quickly;
2. It has wide pressure range, including extra high pressure (X), high pressure (H), standard and large volume(L) to choose from;
3. It is compact, small size and light weight. It is easy to install and dismantle.
4. The valve body is made of brass. Its coil has a Heat resistance classification of Class B. The standard seal material is FPM-F. Please contact us if other material are required.
5. The protection class of the coil is IP65 and there is a choice for grommet or terminal electrical entry.

Inner structure

2KW030(Grommet)

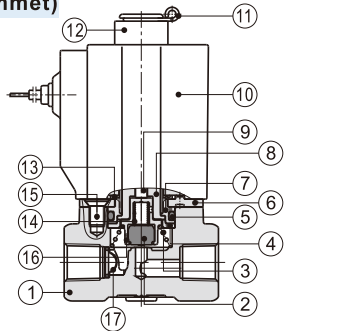

No.	Item	No.	Item
1	Body	10	Coil assembly
2	Airtight ring	11	E Clip
3	Spring	12	Position ring
4	Bead flange	13	Washer
5	O-ring	14	Spring
6	Fixed plate	15	Screw
7	Fixed cap	16	Airtight bush
8	Electromagnet	17	Filter
9	Man drill		

Specification

Model\Item	Port size [Note1]	Orifice size (Ømm)	Cv	Valid area or section (mm ²)	Weight [Note2](g)	Max. operating pressure differentia		Proof pressure	
						MPa	psi	MPa	psi
2KW030	-06 1/8"	1.5	0.10	1.8	315	2.0	300	3.0	450
	-08 1/4"								
2KWH030	-06 1/8"	2.0	0.18	3.0	315	1.5	220		
	-08 1/4"								
2KW030	-06 1/8"	3.0	0.33	6.0	305	0.7	100		
	-08 1/4"								
2KWL030	-06 1/8"	4.0	0.55	10.0	315	0.4	60		
	-08 1/4"								
2KW050	-10 3/8"	3.0	0.34	6.1	635	2.0	300		
	-15 1/2"								
2KWH050	-10 3/8"	4.0	0.55	10.0	635	1.5	220		
	-15 1/2"								
2KW050	-10 3/8"	5.0	0.83	15.0	635	0.7	100		
	-15 1/2"								
2KWL050	-10 3/8"	7.0	1.40	25.0	635	0.4	60		
	-15 1/2"								

[Note1] G thread is available.

[Note2] The weight in the table is the terminal valve's weight, 2KW030 series grommet valve's weight is 10g less than terminal's. 2KW050series grommet valve's weight is 20g less than terminal's.

Specification of coil

Valve type	Coil type	Power type	Frequency (Hz)	Voltage range	Electrical entry	Power Consumption (VA/W)	Insulation	Temp. rise(°C)
2KW□030	CDA116 CLA116	AC	50	± 15%	Terminal (CDA)	15.0VA	Class B	50
			60			11.0VA		40
		DC	-	± 10%		6.5W		30
2KW□050	CDA170 CLA170	AC	50	± 15%	Grommet (CLA)	35.0VA		65
			60			30.0VA		60
		DC	-	± 10%		10.5W		40

Valve's specification

Acting		Direct acting				
Initial state		Normally opened				
Adaptable fluid		Air, Water, Oil				
Viscosity limit		Under 20CST				
Ambient and fluid temperature (°C)		Water		Air	Oil	Ambient
		Max.	80	90	80	70
		Min.	1	-20 [Note1]	-10 [Note2]	-20

[Note1] Dew point: -20(°C) or less;

[Note2] 50CST or less.

Ordering code

Ordering code of valves

2KW H 030 08 A □ G



① Model	② Pressure condition	③ Size series	④ Port size	⑤ Voltage	⑥ Electrical entry	⑦ Thread type
2KW: 2/2 way direct-acting and normally opened	X: Extra high pressure H: High pressure Blank: Standard L: Large volume	030: 030 Series 050: 050 Series	06: 1/8" 08: 1/4" 10: 3/8" 15: 1/2"	A: AC220V B: DC24V C: AC110V E: AC24V F: DC12V	Blank: Terminal I: Grommet	G: G

Ordering code of accessories

Ordering code of accessories is the same as 2S series valve's, Please refer to P148 for details of ordering code.

Fluid control valve(2/2 way)

2KW Series (Direct-acting and normally opened)

Flow chart

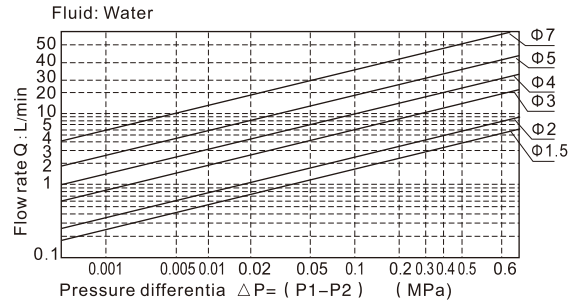
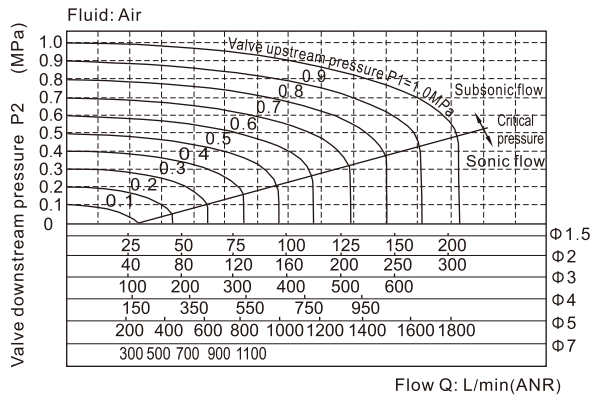

Dimensions

2KW□030 (Terminal)

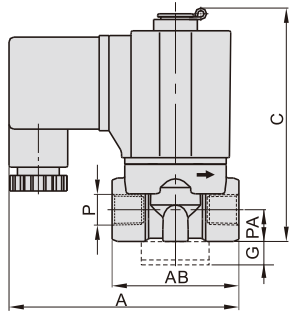
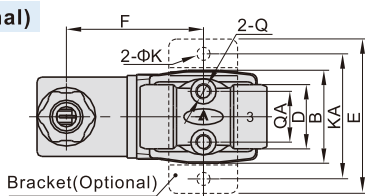

2KW□030(Grommet)

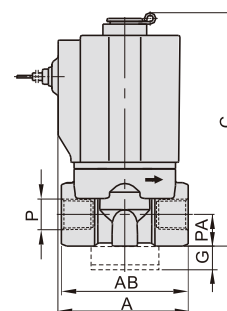
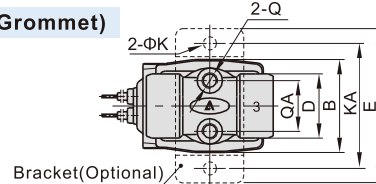

2KW□050 (Terminal)

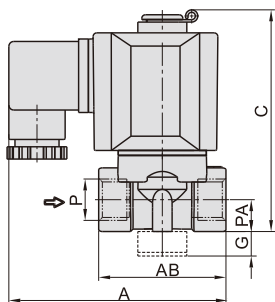
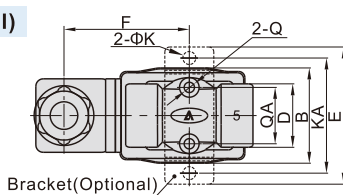

2KW□050 (Grommet)

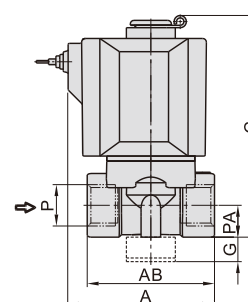
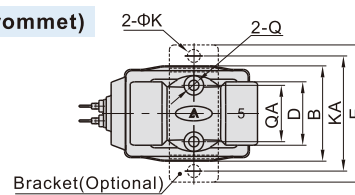

Model\Item	A	AB	B	C	D	E	F	G	K	KA	P	PA	Q	QA
2KW□030-06	72.5	40	29.5	76	20	49	43.5	10	5.3	40	1/8"	10	M5	16
2KW□030-08	72.5	40	29.5	76	20	49	43.5	10	5.3	40	1/4"	10	M5	16
2KW□050-10	89.5	52	39	92	26	56	51	10	5.3	48	3/8"	13	M5	23
2KW□050-15	89.5	52	39	92	26	56	51	10	5.3	48	1/2"	13	M5	23

Model\Item	A	AB	B	C	D	E	G	K	KA	P	PA	Q	QA
2KW□030-06	41	40	29.5	76	20	49	10	5.3	40	1/8"	10	M5	16
2KW□030-08	41	40	29.5	76	20	49	10	5.3	40	1/4"	10	M5	16
2KW□050-10	60	52	39	92	26	56	10	5.3	48	3/8"	13	M5	23
2KW□050-15	60	52	39	92	26	56	10	5.3	48	1/2"	13	M5	23