

Control valve(3/2way)

M3 Series

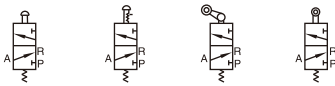

Symbol



Product feature

1. Exhaust outlet locates over the (body), which is convenient to install muffler to decrease noise and pollution.
2. The external force required by direction-change of series of M3B, M3R and M3L is provided by external mechanism, which can be used for position test or stroke switch] limit switch.
3. M3C, M3D, M3Y, M3PF, M3PM, M3PP, M3PL and M3HS are operated manually, owning control joints with several structure forms and suitable for application under different conditions.
4. It is in sliding column structure that the control force is not influenced by working pressure (that is, there is no back pressure effect); internal circle is sealed with good tightness and the direction-change is sensitive.
5. No need to add oil for lubrication.
6. Multi-mounting makes it convenient to install and apply;
7. The control joints of series of M3C, M3D, M3Y, M3R, and M3L are made of metal which has long service life and more reliable and steady performance.

Inner structure

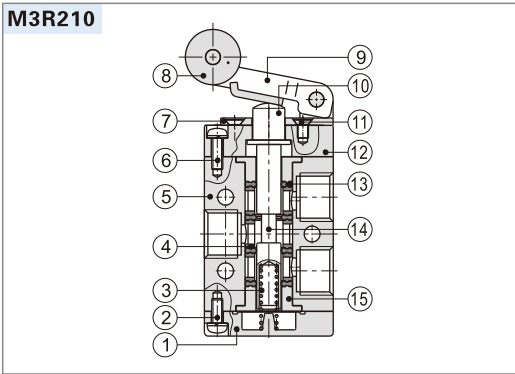

No.	Item	No.	Item	No.	Item
1	Bottom cover	6	Screw	11	Screw
2	Screw	7	Roller holder	12	Fore cover
3	Spring	8	Roller	13	Piston O-ring
4	Spacer	9	Rotating block	14	Spool
5	Body	10	Axle	15	Positioning block

Flow chart

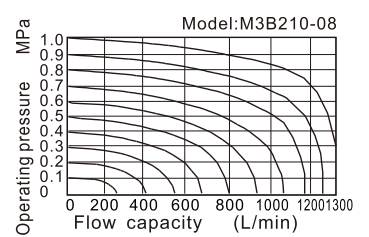
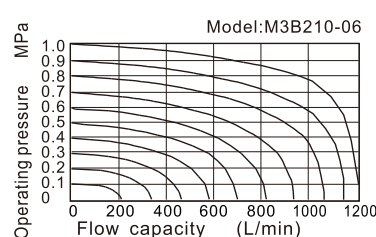
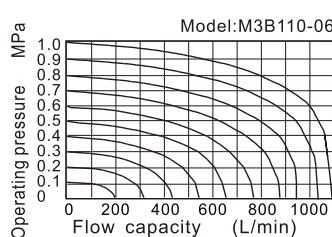
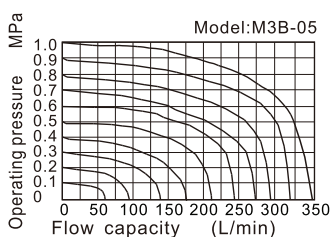

Specification

Model	M3B	M3C	M3D	M3R	M3L	M3Y	M3PM	M3PP	M3PF	M3PL	M3HS
Fluid	Air (to be filtered by 40 μm filter element)										
Operating	External control direct acting type										
Port size [Note1]	05: M5 06: 1/8" 08: 1/4"										
Orifice size	Mini type					05: 2.5mm ² (Cv=0.14)					
	110					06: 8.0mm ² (Cv=0.45)					
	210					06: 9.0mm ² (Cv=0.50) 08: 12.0mm ² (Cv=0.67)					
Valve type	3/2 Way										
Lubrication [Note2]	Not required										
Pressure range	0~1.0MPa(0~145psi)										
Proof pressure	1.5MPa(215psi)										
Temperature °C	-20~70										
Material body	Aluminum alloy										

[Note1] G thread is available.

[Note2] Once lubricated air is used, continue with same medium to optimise valve life span. It is suggested to use ISO VG32 lubricant or the oil with the same grade.

Reversal stroke

Common type						Mini type		
Type	Spool stroke	Button stroke	Type	Spool stroke	Roller(handle) stroke	Type	Spool stroke	Roller stroke
M3B	2.0~3.3	-	M3R	2.0~3.0	4.6~6.8	M3B05	2.0~3.3	-
M3PF	2.0~3.3	3.8~5.1	M3L	2.0~3.0	5.0~7.8	M3R05	2.0~3.0	6.0~8.5
M3PP	2.0~3.3	3.8~5.1	M3C	2.0~3.0	11.0~16.0	M3L05	2.0~3.0	7.0~10.0
M3PM	2.0~3.3	3.8~5.1	M3D	2.0~3.0	5.5~8.0			
M3PL	2.0~3.3	5.9~7.2						
M3HS	2.0~3.3	5.1~6.4						

Ordering code

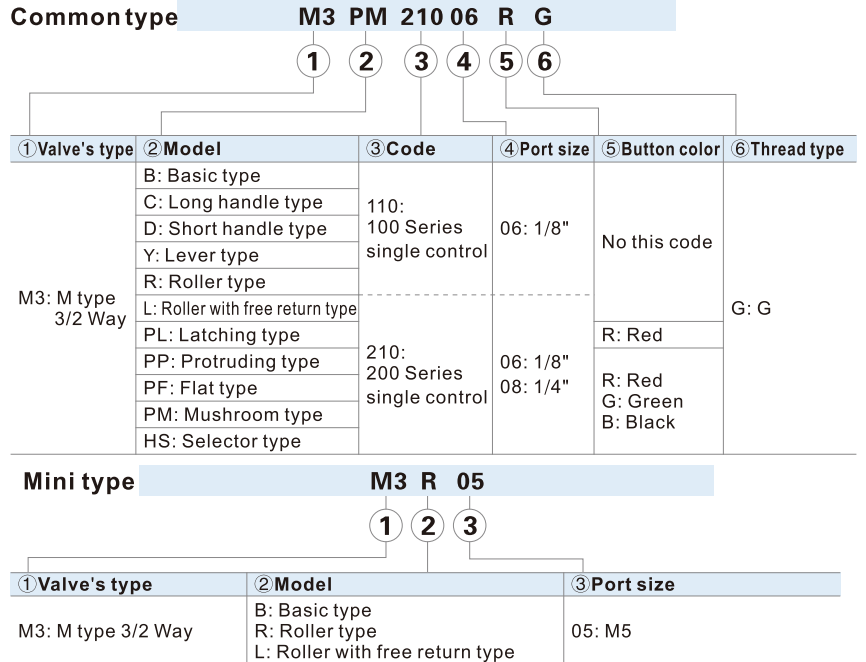

Control valve(3/2way)

M3 Series

Installation and Application

- 1) Body and panel installation (picture at right) :
- 2) The control set is made of engineering plastic which only allows manual operation and switching valves through metal impact is forbidden.
- 3) The series of M3B, M3C, M3D, M3PM, M3PF and M3PP get the function of automatic restoration. The hand valves of M3Y, M3HS and M3PL are in the type of manual restoration. M3PL will be restored by turning the revolve button after being pressed into orientation.
- 4) Pay attention to the reversing stroke. The reversing stroke can not surpass its stroke stipulated in stroke control table when the direction-change of the valve is forced by any external forces, otherwise it will cause the damage of the valve.
- 5) The M3L can only switch the valve in single direction (impact from right to left). The impact from the other direction is invalid (from left to right).
- 6) Control joint combination can be ordered individually. Please refer to the table on the right for order details.

Fixation way of body

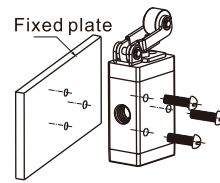

Fixation way of panel

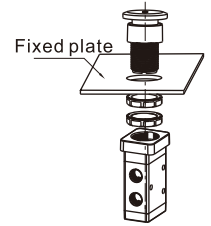

Dimensions

Common type

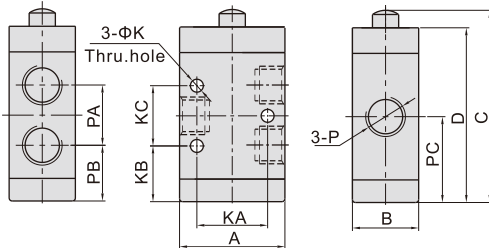

Model\Item	A	B	C	D	K	KA	KB	KC	P	PA	PB	PC
M3B11006	27	18	52	46.5	3.3	18	15.5	16	1/8"	16	15.5	23.5
M3B21006	35	22	63.8	58	4.3	23.5	18.5	20	1/8"	20	18.5	28.5
M3B21008									1/4"			

Mini type

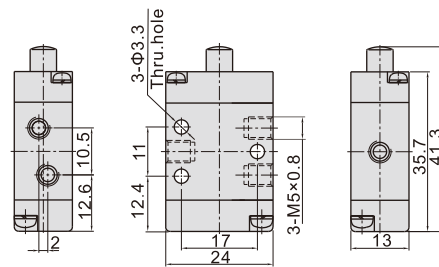

Roller type(R)

Mini type

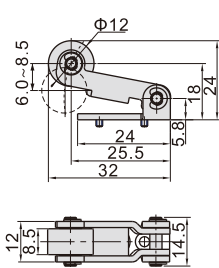

Common type

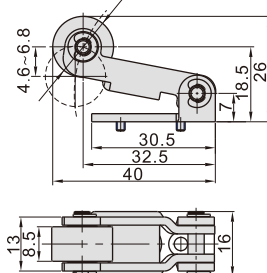

Model	Roller type(R)	
How to order	Ordering code	M3R05-P14A M3R210-P14A
	Type	M3R05 Roller type control set M3R210 Roller type control set
Applicable products		M3R05 M3R110, M3R210

Roller with free return type(L)

Mini type

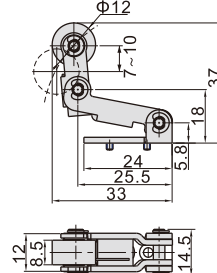

Common type

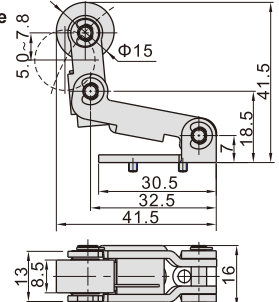

Model	Roller with free return type(L)	
How to order	Ordering code	M3L05-P14A M3L210-P14A
	Type	M3L05 Roller with free return type control set M3L210 Roller with free return type control set
Applicable products		M3L05 M3L110, M3L210

Short handle type(D)

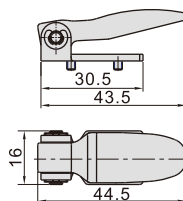

Model	Short handle type(D)	
How to order	Ordering code	M3D210-P13A
	Type	M3D210 Short handle type control set
Applicable products		M3D110, M3D210

Long handle type(C)

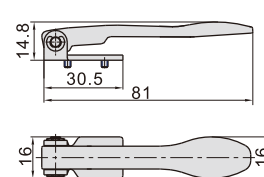

Model	Long handle type(C)	
How to order	Ordering code	M3C210-P13A
	Type	M3C210 Long handle type control set
Applicable products		M3C110, M3C210

Control valve(3/2way)

M3 Series

Lever type(Y)

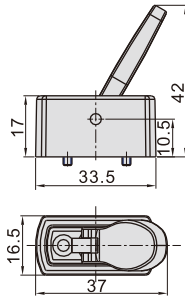

Model		Lever type(Y)
How to order	Ordering code	M3Y210-P13A
	Type	M3Y210 Lever type control set
Applicable products		M3Y110, M3Y210

Latching type(PL)

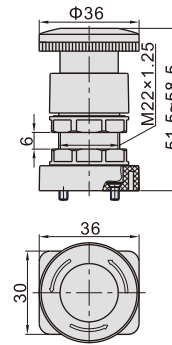

Model		Latching type (only red)(PL)
How to order	Ordering code	S3PL05-P12A
	Type	S3PL Latching type control set (Red)
Applicable products		M3PL110, M3PL210

Mushroom type(PM)

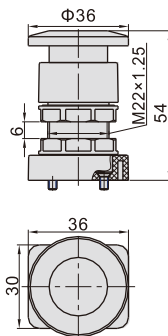

Model		Mushroom type(PM)
How to order	Ordering code	S3PM05-P11A
	Type	S3PM mushroom type control set (Green)
	Ordering code	S3PM05-P12A
	Type	S3PM mushroom type control set (Red)
	Ordering code	S3PM05-P13A
Type	S3PM mushroom type control set (Black)	
Applicable products		M3PM110, M3PM210

Protruding type(PP)

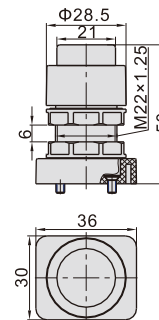

Model		Protruding type(PP)
How to order	Ordering code	S3PP05-P11A
	Type	S3PP protruding type control set (Green)
	Ordering code	S3PP05-P12A
	Type	S3PP protruding type control set (Red)
	Ordering code	S3PP05-P13A
Type	S3PP protruding type control set (Black)	
Applicable products		M3PP110, M3PP210

Flat type(PF)

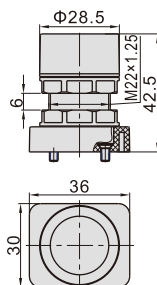

Model		Flat type(PF)
How to order	Ordering code	S3PF05-P11A
	Type	S3PF flat type control set (Green)
	Ordering code	S3PF05-P12A
	Type	S3PF flat type control set (Red)
	Ordering code	S3PF05-P13A
Type	S3PF flat type control set (Black)	
Applicable products		M3PF110, M3PF210

Selector type(HS)

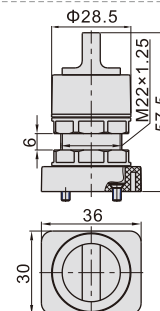

Model		Selector type(HS)
How to order	Ordering code	S3HS05-P11A
	Type	S3HS selector type control set (Green)
	Ordering code	S3HS05-P12A
	Type	S3HS selector type control set (Red)
	Ordering code	S3HS05-P13A
Type	S3HS selector type control set (Black)	
Applicable products		M3HS110, M3HS210