

I Knuckle



Table for I knuckle and cylinder

Cylinder Accessory	SE						SAI									
	32	40	50	63	80	100	125	32	40	50	63	80	100	125	160	200
F-M10X125I	●							●								
F-M12X125I		●							●							
F-M16X150I			●	●						●	●					
F-M20X150I					●	●						●	●			
F-M27X200I							●							●		
F-M36X200I															●	●

Cylinder Accessory	SGC			
	125	160	200	250
F-M27X200I	●			
F-M36X200I		●	●	
F-M42X200I				●

Cylinder Accessory	MI						MPG						
	8	10	12	16	20	25	32	40	6	8	10	12	16
F-M3X050I									●				
F-M4X070I	●	●								●	●		
F-M5X080I												●	●
F-M6X100I			●	●									
F-M8X125I					●								
F-M10X125I						●	●						
F-M12X125I							●						

Ordering code

F-M16X150 I			
① Accessories code	② Screw thread	③ Thread pitch	④ Code
	M3: M3	050: 0.5mm	I: I Knuckle
	M4: M4	070: 0.7mm	
	M5: M5	080: 0.8mm	
	M6: M6	100: 1.0mm	
	M8: M8		
	M10: M10	125: 1.25mm	
	M12: M12		
	M16: M16	150: 1.5mm	
	M20: M20		
	M27: M27		
	M36: M36	200: 2.0mm	
	M42: M42		

Dimensions

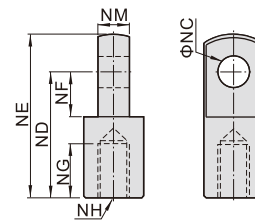

Type/Item	NC	ND	NE	NF	NG	NH	NM
F-M3x050I	3	12	15.5	5	5	M3×0.5	3
F-M4x070I	4	16	21	6.8	8	M4×0.7	4
F-M5x080I	5	25	32	14.1	7.5	M5×0.8	6.3
F-M6x100I	6	21	28	8.5	8	M6×1.0	6
F-M8x125I	8	30	40	11	15	M8×1.25	8
F-M10x125I	10	40	50	15	20	M10×1.25	10
F-M12x125I	12	48	62	24	20	M12×1.25	12
F-M16x150I	16	64	82	32	23	M16×1.5	16
F-M20x150I	20	80	102	40	30	M20×1.5	20
F-M27x200I	30	110	139	51	45	M27×2.0	30
F-M36x200I	35	144	181	65	55	M36×2.0	35
F-M42x200I	40	168	211	85	62	M42×2.0	40

Y Knuckle



Table for Y knuckle and cylinder

Cylinder Accessory	SE						SAI									
	32	40	50	63	80	100	125	32	40	50	63	80	100	125	160	200
F-M10X125Y	●							●								
F-M12X125Y		●							●							
F-M16X150Y			●	●						●	●					
F-M20X150Y					●	●						●	●			
F-M27X200Y														●		
F-M36X200Y															●	●

Cylinder Accessory	SGC			
	125	160	200	250
F-M27X200Y	●			
F-M36X200Y		●	●	
F-M42X200Y				●

Cylinder Accessory	MI						MPG						
	8	10	12	16	20	25	32	40	6	8	10	12	16
F-M3X050Y									●				
F-M4X070Y	●	●								●	●		
F-M5X080Y												●	●
F-M6X100Y			●	●									
F-M8X125Y					●								
F-M10X125Y						●		●					
F-M12X125Y									●				

Ordering code

F-M16X150 Y



① Accessories code	② Screw thread	③ Thread pitch	④ Code
	M3: M3	050: 0.5mm	Y:Y Knuckle
	M4: M4	070: 0.7mm	
	M5: M5	080: 0.8mm	
	M6: M6	100: 1.0mm	
	M8: M8	125: 1.25mm	
	M10: M10		
	M12: M12		
	M16: M16	150: 1.5mm	
	M20: M20		
	M27: M27	200: 2.0mm	
	M36: M36		
	M42: M42		

Dimensions

M10 and below

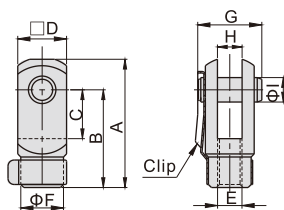

Type\Item	A	B	C	D	F
F-M3X050Y	15.5	12	5	6	6
F-M4X070Y	22	16	8	8	7
F-M5X080Y	28	21	10.2	12	10
F-M6X100Y	32	24	12	12	10
F-M8X125Y	42	32	16	16	14
F-M10X125Y	52	40	20	19	18

Type\Item	E	G	H	I
F-M3X050Y	M3×0.5	9	3	3
F-M4X070Y	M4×0.7	11.5	4	4
F-M5X080Y	M5×0.8	15.5	6.5	5
F-M6X100Y	M6×1.0	16	6	6
F-M8X125Y	M8×1.25	21	8	8
F-M10X125Y	M10×1.25	25	10	10

Others

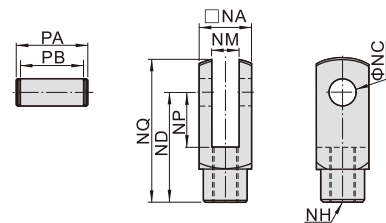

Type\Item	NA	NC	ND	NP	NQ
F-M12X125Y	25.4	12	48	24	62
F-M16X150Y	32	16	64	32	80
F-M20X150Y	44.4	20	80	40	102
F-M27X200Y	54	30	110	55	139
F-M36X200Y	70	35	144	73	179
F-M42X200Y	85	40	168	86	211

Type\Item	NM	NH	PA	PB
F-M12X125Y	12	M12×1.25	32.4	26.2
F-M16X150Y	16	M16×1.5	39	32.8
F-M20X150Y	20	M20×1.5	53.4	45.2
F-M27X200Y	30	M27×2.0	64.2	54.8
F-M36X200Y	35	M36×2.0	80.2	70.8
F-M42X200Y	40.3	M42×2.0	115	93

Cylinder joint accessory



Floating Joint



Effectively dissolving the extra external force caused by eccentricity

Internal use of ball head structure

The internal use of ball head structure, flexible swing; axial no gap, deflection angle wide.

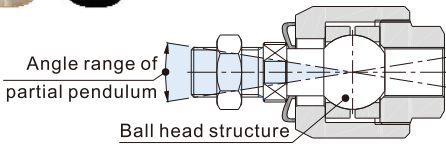

Various thread type specifications

Thread type			
M3X0.5	M8X1.25	M16X1.5	M22X1.5(New)
M4X0.7	M10X1.25	M18X1.5	M26X1.5(New)
M5X0.8	M12X1.25	M20X1.5	M27X2.0(New)
M6X1.0	M14X1.5		M36X2.0(New)



Thread type can be matched with a variety of series cylinders

Table for floating joint and cylinder

Cylinder Accessory	PB		MI								MF				MBL									
	4	6	10	12	16	8	10	12	16	20	25	32	40	20	25	32	40	20	25	32	40	50	63	
F-M3X050F		●																						
F-M4X070F			●			●	●																	
F-M5X080F				●	●																			
F-M6X100F								●	●															
F-M8X125F										●														
F-M10X125F											●	●												
F-M12X125F													●											
F-M14X150F														●										

Cylinder Accessory	SGC				SE					SAI											
	125	160	200	250	32	40	50	63	80	100	125	32	40	50	63	80	100	125	160	200	
F-M10X125F					●							●									
F-M12X125F						●							●								
F-M16X150F							●	●						●	●						
F-M20X150F									●	●						●	●				
F-M27X200F	●										●								●		
F-M36X200F		●	●																●	●	

Cylinder Accessory	ACQ									
	12	16	20	25	32	40	50	63	80	100
F-M8X125F			●							
F-M10X125F				●						
F-M14X150F					●	●				
F-M18X150F							●	●		
F-M22X150F									●	
F-M26X150F										●

Ordering code

F - M22 X 150 F



① Accessories code																												
② Screw thread	M3	M4	M5	M6	M8	M10	M12	M14	M16	M18	M20	M22	M26	M27	M36													
③ Thread pitch	050:0.5mm				070:0.7mm				080:0.8mm				100:1.0mm				125:1.25mm				150:1.5mm				200:2.0mm			
④ Code	F: Floating joint																											

Dimensions

M6 and below

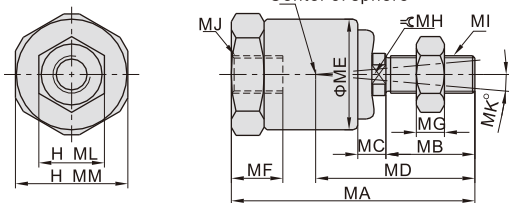

Type/Item	MA	MB	MC	MD	ME	MF	MG	MH	MI\MJ	ML	MM
F-M3X050F	23.5	7.5	3	15	11.8	5.5	2.4	4	M3×0.5	5.5	13
F-M4X070F	26	9.5	3	17	11.8	6	3	4	M4×0.7	7	13
F-M5X080F	34.5	13.5	3.5	22.8	13.8	8	4	6	M5×0.8	8	14
F-M6X100F	34.5	13.5	3.5	22.8	13.8	8	4	6	M6×1.0	10	14

Note: Angle compensation: $\pm 5^\circ$. Radial direction compensation: 0.5

M8 and above

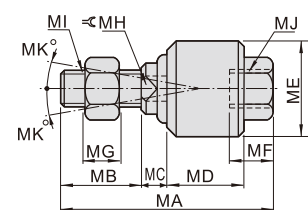

Type/Item	MA	MB	MC	MD	ME	MF	MG	MH	MI/MJ	MK
F-M8X125F	51	20	6	17	24	10.5	6	8	M8×1.25	13
F-M10X125F	58	22	7	21	26	11	6	10	M10×1.25	12
F-M12X125F	58	22	8	21	28	11.5	7	12	M12×1.25	12
F-M14X150F	70	22.5	8.5	28	34.5	16	8	15	M14×1.5	12
F-M16X150F	90	27	10	41	44.5	19	8	17	M16×1.5	7
F-M18X150F	92	27	10	41	44.5	21	11	18	M18×1.5	7
F-M20X150F	102	29	13	46	53	22	10	22	M20×1.5	10
F-M22X150F	108	32	13	46	53	25	13	22	M22×1.5	5
F-M26X150F	120	32	14.5	52.5	59.5	25	13	27	M26×1.5	5
F-M27X200F	136.5	40	14.5	52.5	59.5	40	13.5	27	M27×2.0	5
F-M36X200F	194.5	60	20.5	77.5	84	54	18	36	M36×2.0	5



Universal Joint



Table for universal joint and cylinder

Cylinder Accessory	SE						SAI									
	32	40	50	63	80	100	125	32	40	50	63	80	100	125	160	200
F-M10X125U	●							●								
F-M12X125U		●							●							
F-M16X150U			●	●						●	●					
F-M20X150U					●	●						●	●			
F-M27X200U														●		
F-M36X200U															●	●

Cylinder Accessory	SGC			
	125	160	200	250
F-M27X200U	●			
F-M36X200U		●	●	

Cylinder Accessory	ACQ									
	12	16	20	25	32	40	50	63	80	100
F-M5X080U	●									
F-M6X100U		●								
F-M8X125U			●							
F-M10X125U				●						
F-M14X150U					●	●				
F-M18X150U							●	●		
F-M26X150U										●

Cylinder Accessory	MF				MBL					
	20	25	32	40	20	25	32	40	50	63
F-M6X100U										
F-M8X125U	●				●					
F-M10X125U		●	●			●	●			
F-M12X125U								●		
F-M14X150U				●					●	●

Cylinder Accessory	PB					MI							
	4	6	10	12	16	8	10	12	16	20	25	32	40
F-M4X070U			●			●	●						
F-M5X080U				●	●								
F-M6X100U								●	●				
F-M8X125U										●			
F-M10X125U											●	●	
F-M12X125U													●

Ordering code

F-M10X125 U



① Accessories code	② Screw thread	③ Thread pitch	④ Code
	M4: M4	070: 0.7mm	U: Universal joint
	M5: M5	080: 0.8mm	
	M6: M6	100: 1.0mm	
	M8: M8	125: 1.25mm	
	M10: M10		
	M12: M12		
	M14: M14		
	M16: M16	150: 1.5mm	
	M18: M18		
	M20: M20		
	M26: M26		
	M27: M27	200: 2.0mm	
	M36: M36		

Dimensions

M8 and below

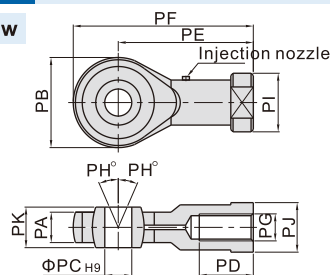

M10 and above

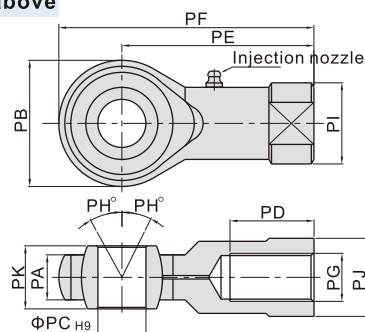

Type/Item	PA	PB	PC	PD	PE	PF	PG	PH	PI	PJ	PK
F-M4X070U	6	18	5	10	27	36	M4×0.7	13	12.5	10	8
F-M5X080U	6	18	5	10	27	36	M5×0.8	13	12.5	10	8
F-M6X100U	6.8	20	6	12	30	40	M6×1.0	13	13	11	9
F-M8X125U	9	24	8	16	36	48	M8×1.25	13	16	14	12
F-M10X125U	11	26	10	20	43	56	M10×1.25	13	19	17	14
F-M12X125U	12	32	12	22	50	66	M12×1.25	13	22	19	16
F-M14X150U	14	36	14	28	57	75	M14×1.5	13	25	22	19
F-M16X150U	15	40	16	28	64	84	M16×1.5	15	27	22	21
F-M18X150U	16.5	46	18	30	71	94	M18×1.5	15	31	27	23
F-M20X150U	18	46	20	33	77	100	M20×1.5	15	34	30	25
F-M26X150U	22	60	25	48	94	124	M26×1.5	15	42	36	31
F-M27X200U	25	70	30	51	110	145	M27×2.0	15	50	41	37
F-M36X200U	27.5	80	35	56	125	165	M36×2.0	15	57.5	50	43